



Nice

Next Autotorque®

The new tubular motor
for sun awnings (20-50 Nm)

Why Nice

Unique solutions combining technology, innovation, quality and design to make even the smallest everyday gestures extraordinary.

Automation systems for blinds, awnings, rolling shutters and sun screens in general make the home more comfortable and guarantee intelligent management of sunlight and the temperature inside the building.



Sustainability

Heating and cooling account for 80% of energy consumption in residential buildings. The use of an appropriate sunscreen system can limit carbon emissions and generate energy savings amounting to around sixty times the system's CO2 footprint over its twenty-year lifetime. *

During the summer, Nice sunscreen systems control overheating and reduce cooling needs, while in winter they improve the building's thermal resistance. Nice automation systems for blinds, awnings and rolling shutters allow correct management of the light. The right amount of sunlight and daylight has a positive effect on health, learning ability and productivity at work, generally improving the quality of life of the building's inhabitants.

The installation and correct use of sun screen automations can reduce consumption by improving the building's energy efficiency, generating a positive effect on the family budget and entire planet.

**source: ES-SO European Solar-Shading Organization*

Quality

Nice products stand out for their advanced electronics, high aesthetic quality and attention to detail. Nice tubular motor lines are today designed and developed by a highly qualified and specialised team of professionals, integrating Made in Italy creativity and Made in Germany quality and reliability. The result is products with high standards of design, innovation and functionality.

Warranty

Safety and reliability are fundamental values for Nice. Every day, the company's products are rigorously and precisely tested in the 1000 sq m of laboratories in the R&D centre, following procedures at the forefront of technology and using the most advanced instruments available to guarantee maximum standards of technology and quality.

Nice tubular motors are controlled and tested to provide a long warranty: 5 years from the production date indicated on each product.



Nice

Next Autotorque®

The new tubular motor
for sun awnings (20-50 Nm)

Maximum efficiency
and control of movement.



Plug-in cable

The product is supplied with pre-mounted cables and supports. If needed, the cable can easily be unplugged and replaced without tools.

Star Head

Motor head compatible with star-shaped supports. Also suitable for maintenance interventions and replacing previous applications.

Energy saving

The leading technology reduces energy consumption by 35% with respect to comparable motors

 35%

Nice

Advantageous for both installers and users:

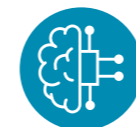

Self-learning mode

The motor can be used for arm awnings (20-50 Nm).

With DC technology, the motor recognises the force required during the first phase of programming and installation, and adapts to the application.



Climatic speed control

The motor adjusts the awning opening and closing speed according to the weather conditions and lighting, guaranteeing safety and comfort.

When the climatic sensor detects an unexpected gust of wind, the awnings close fully in just a few seconds. When the sun starts to set, the climatic sensor detects the fading light and the awnings close gradually to create a relaxing atmosphere.



Low noise performance

The **state-of-the-art braking technology** makes the movement smooth and silent.

Maximum acoustic comfort is guaranteed by the **Soft Start-Stop** function which automatically reduces the speed when approaching the limit switches and the possibility of adjusting the speed to a minimum of 6 rpm.



Quick installation

The motor is ready to use and fast to install, thanks to the **pre-mounted, unpluggable cable.**

Continuous operating time of up to 10 minutes* before activation of the thermal protection: facilitates installation operations.

Manual, semi-automatic or automatic limit switch adjustment.

*it depends on the size of the application



Self-learning mode

Next Autotorque guarantees fluid, silent opening and closing of **sun awnings (20-50 Nm)**.

Its advanced technology **adapts the torque according to the specific application**, providing peak power when required and precise motion adjustment.

Climatic speed control

Depending on the wind signal (detected by the climatic sensor), Next Autotorque is able to close the sun awning quickly (25 rpm), protecting it from damage.

Depending on the sun signal (detected by the climatic sensor), Next Autotorque is able to close the sun awning quickly (6 rpm), protecting it from getting damaged.



Rewarded
for our innovation



Nice

Infinite scenarios with Yubii

Yubii, a single ecosystem to connect, simplify and control all home automations.

Connect automations via the Nice gateway to create personalised scenarios that can be controlled either by smartphone or by setting a button on the bidirectional remote control.



Exclusive functions

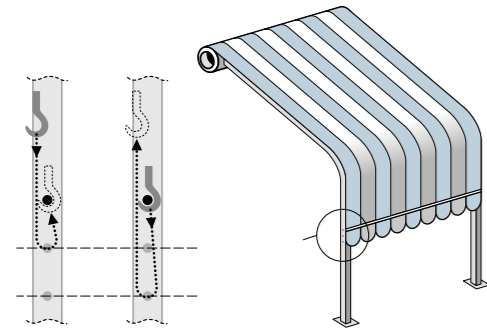

Manual hooking system (FTA)

Manual hooking systems to optimize tensioning force according to the type of fabric and size of blind.

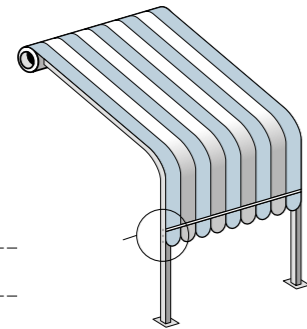

Automatic hooking system (FTC)

Automatic hooking systems to optimize tensioning force according to the type of fabric and size of blind.

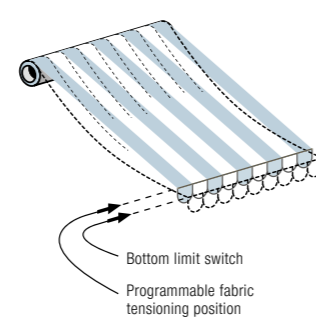

Fabric tensioning system (FRT)

Back release to adjust fabric tensioning system.

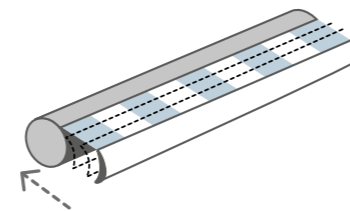

Closing torque reduction system (RDC)

Drive torque reduction system: to stop movement smoothly without straining the fabric in the closed position.

Enjoy effortless sun shading

Enjoy a comfortable and energy-efficient home with automatic awning adjustments based on sunrise and sunset.

Create personalized awning schedules

Create custom schedules for your awning to suit your lifestyle and preferences.



Nice

Next Fit MT Autotorque®

For sun awnings, with electronic limit switch and built-in radio receiver*.

Size M Ø 45 mm.



- SUN AWNINGS
- SELF-LEARNING MODE
- QUICK TO INSTALL
- MOTION CONTROL
- LOW NOISE
- BIDIRECTIONAL RADIO
- CLIMATIC SENSORS
- NICE GREEN INNOVATION

- BiDi
- 230 Vac
- Yubii
- 433 MHz

*available soon in wired version

Manual or semi-automatic limit switch adjustment.

The motor is ready to use and fast to install, thanks to the **pre-mounted, unpluggable cable**.

Continuous operating time of up to 10 minutes (depending on the size of the application) before activation of the thermal protection.

Programmable via TTPRO BD.

Auto-regulation of torque along the stroke.

Options for partially managing the awning: intermediate position and go-to position.

State-of-the-art braking technology: makes the movement smooth and silent.

Soft Stop & Soft Start function: maximum acoustic comfort.

Connection to climatic sensors via radio with user-friendly programming.

TECHNICAL SPECIFICATION

Code	Description	Pcs./pack	Certificates
NX FIT MT AUTOTRQ	Electronic limit switch. 230 Vac, 20 – 50 Nm, 17 rpm	1	

Code	NX FIT MT AUTOTRQ
Power supply (Vac)	230
Frequency (Hz)	50 – 60
Power (W)	130
Absorption (A)	1
Power consumption in standby (W)	<0,5
Cable length (m)	2
Plug-in cable	Yes
IP	44
Nominal torque (Nm)	30
Peak torque (Nm)	50
Rated speed (rpm)	17
Programmable speed (rpm)	from 6 to 24
Continuous operating time (min.)	up to 10 (depending on the size of the application)
Length (L) (mm)	531
Operating temp. (°C min./max.)	-20 /+70°
Noise level (dBA)	45
Installation in parallel	8 motors
Climatic sensor comfort function with solar signal	6 rpm
Climatic sensor safety function with wind signal	24 rpm

PLUG-IN CABLE

Cable length 1.5 m, 3 wires in cable



DIMENSIONS

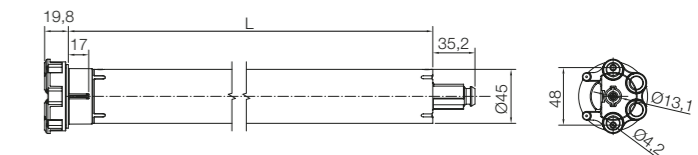

Nice

Adapters M serie Ø 45 mm

To facilitate the choice of adapter compatible with the type of roller in the system, Nice provides the adapters in 1:1 scale and indicates the corresponding adapter code for each.

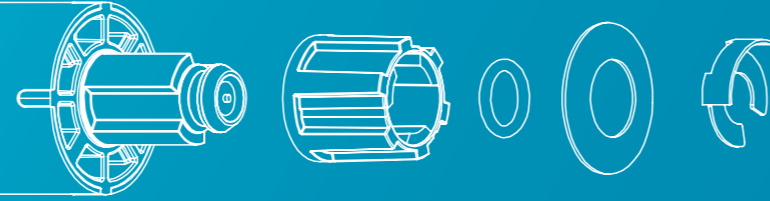

575.01012

Adapter cap Next/Era

Nice

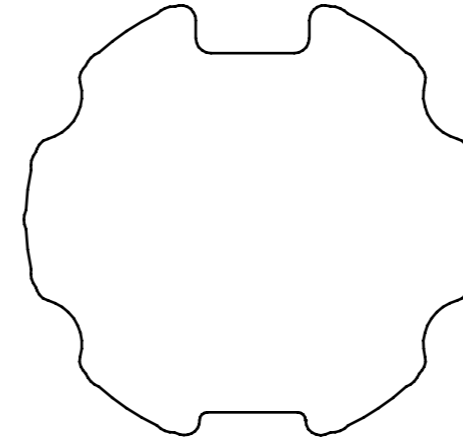

230.310001

Notch 63x1
wheel + crown

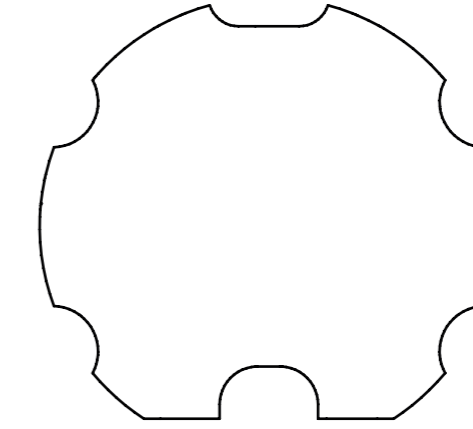

220.190001

Notch 63
wheel + crown

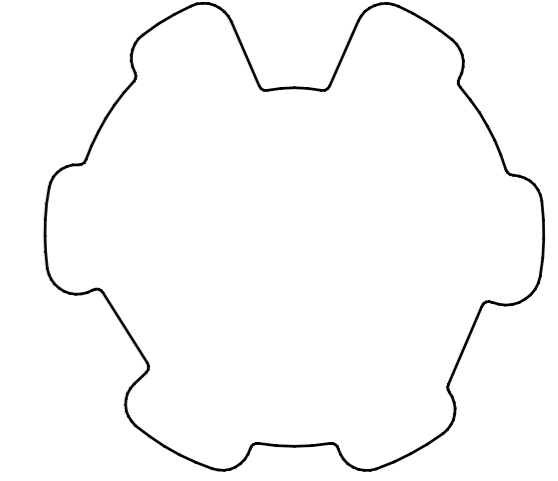

230.650001

Notch 70
wheel + crown

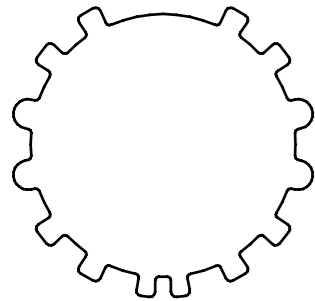

220.180001

Notch 43.5
wheel + crown

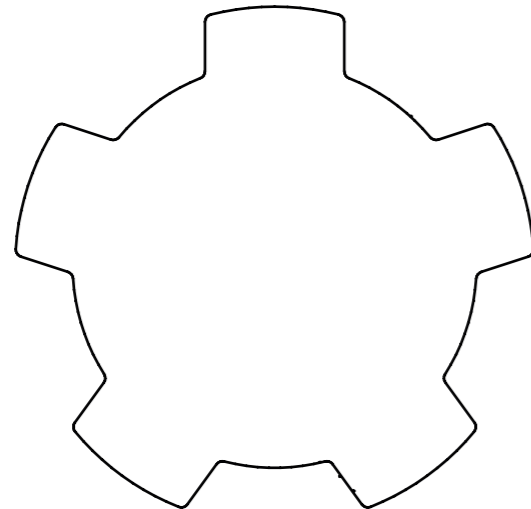

230.280001

Notch 34.3
wheel

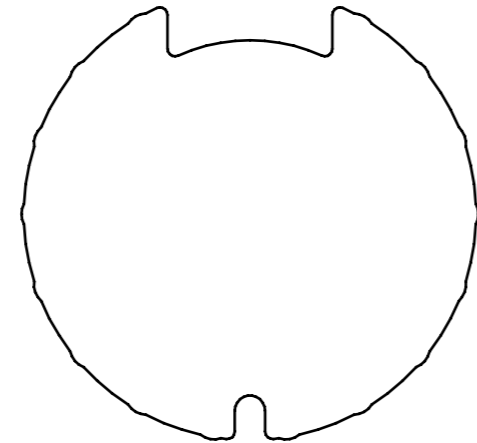

230.420001

Notch 62x0.6
wheel + crown

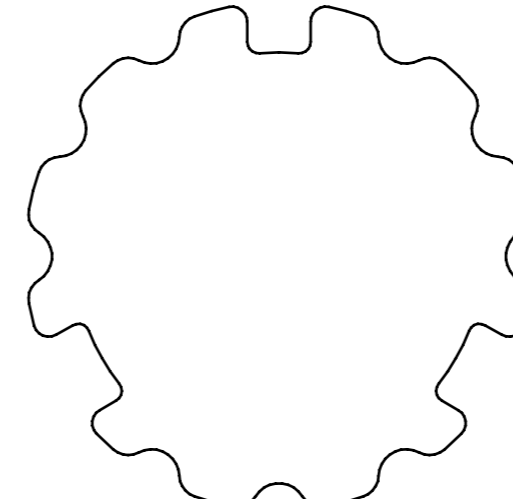

230.540001

Notch 71x1.5
wheel + crown

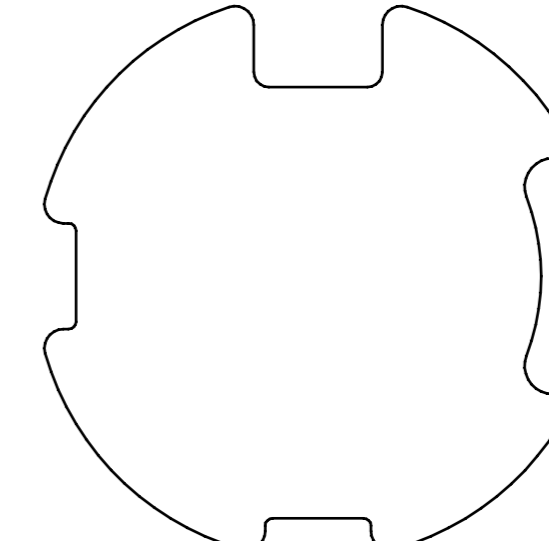

230.150001

Notch 78x1.25
wheel + crown

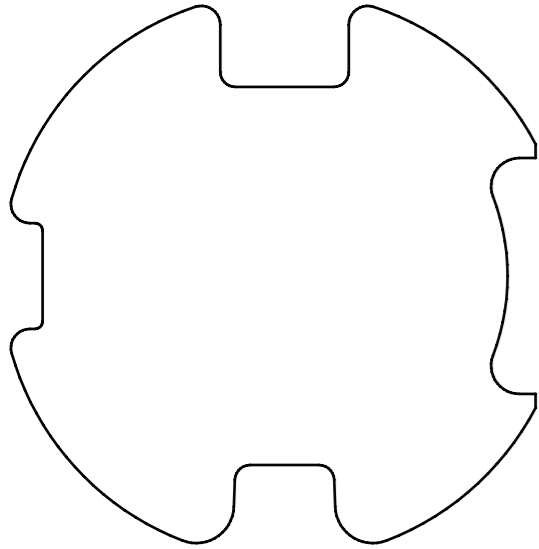

221.290002
Notch 78x1
wheel + crown

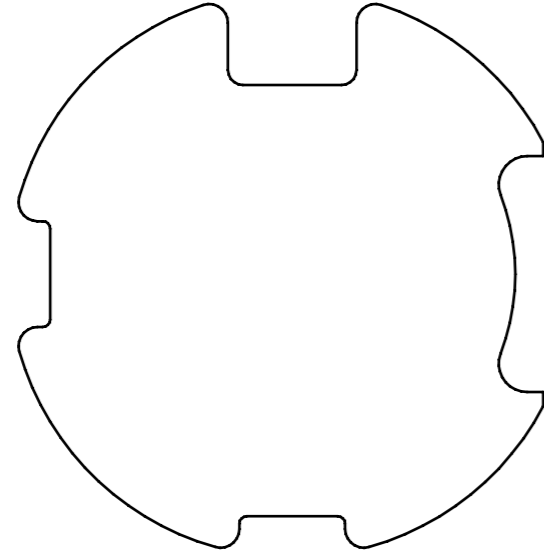

230.260001
Notch 78x1
wheel + crown

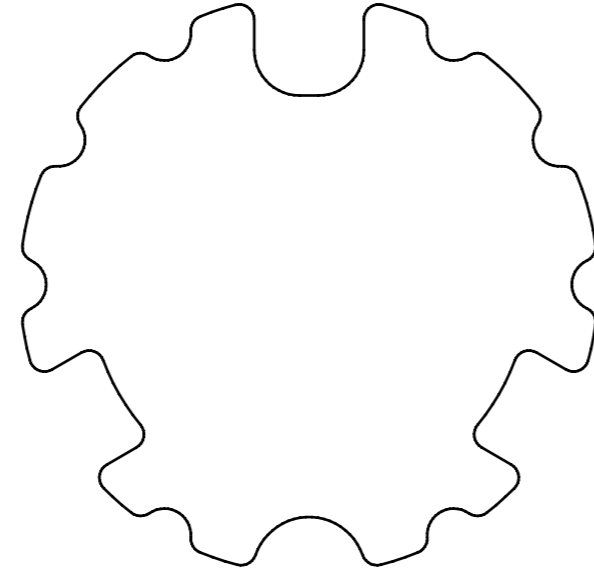

220.880001
Notch 80x1-1.25
wheel + crown

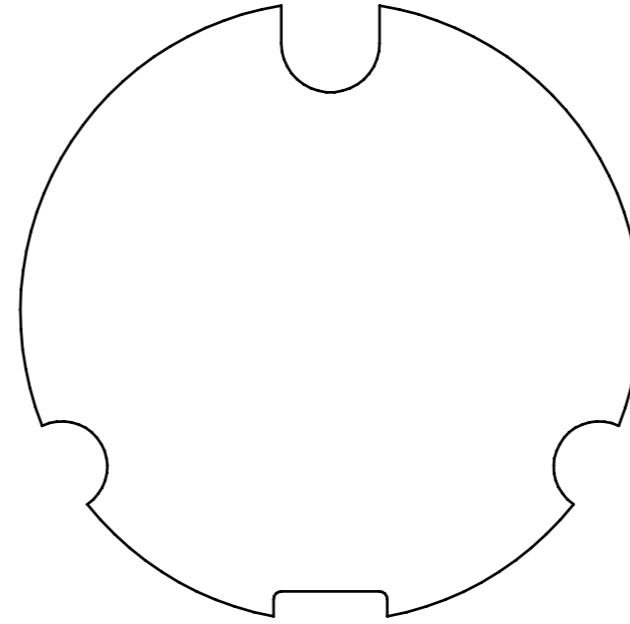

230.170001
Notch 85x1
wheel + crown

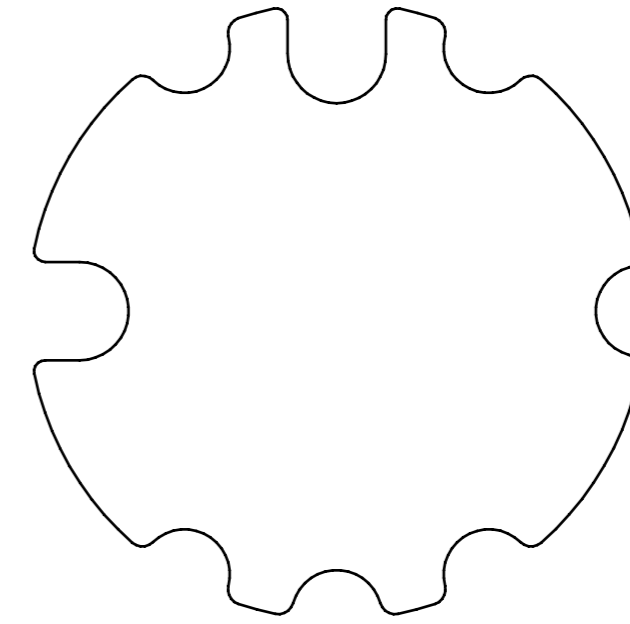

230.480001
Notch 85x1.2
wheel + crown

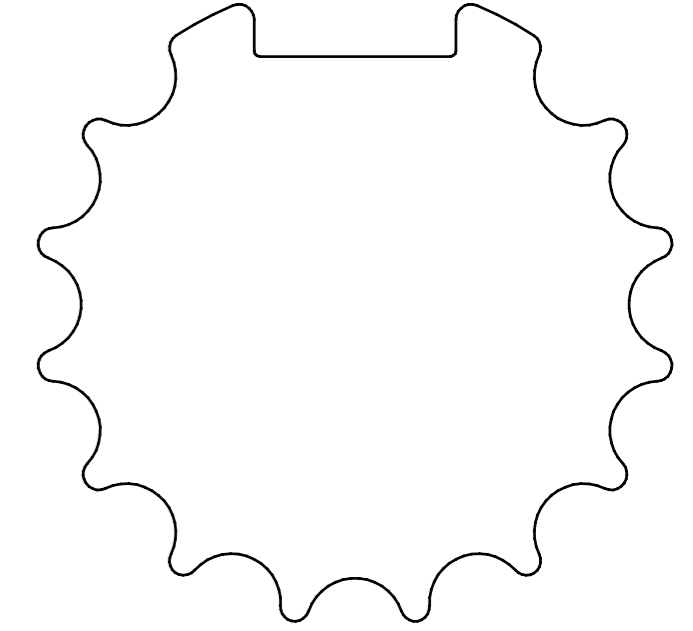

230.530001
Notch 89
wheel + crown

Nice

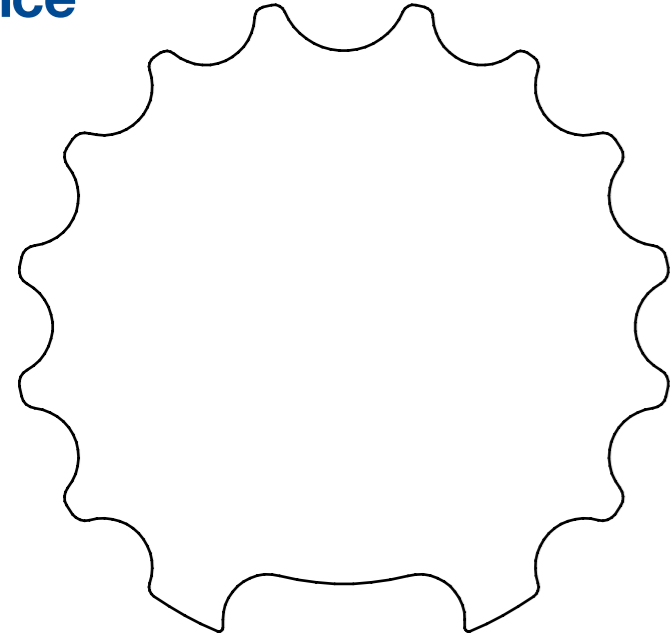

230.580001
Notch 90.5
wheel + crown

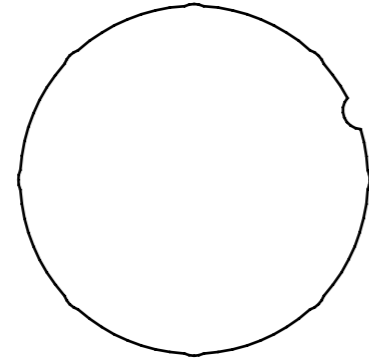

131.162901
Round 50x1.5
wheel + crown

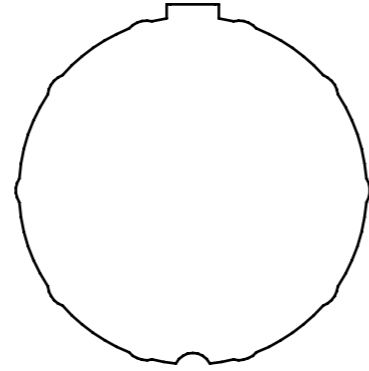

131.169901
Notch 50x1.5
wheel + crown

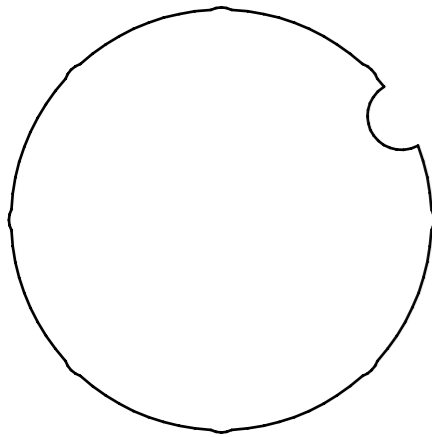

230.440001
Round 60x2-1.5
wheel + crown

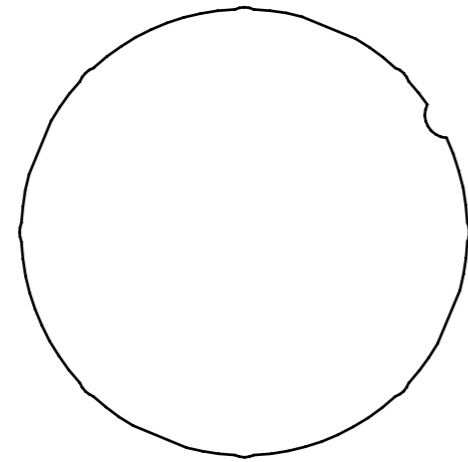

230.450001
Round 63x1.5
wheel + crown

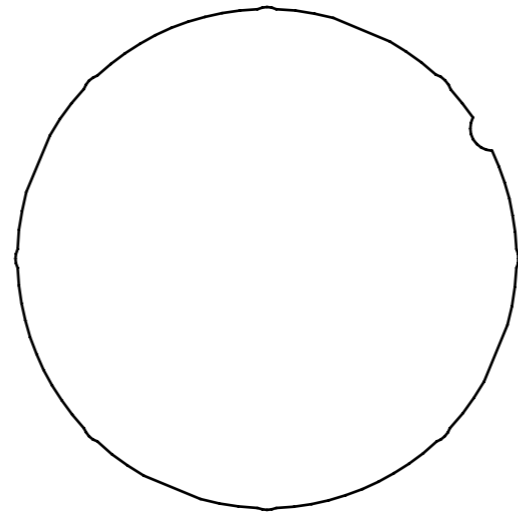

230.460001
Round 70x1.5
wheel + crown

Nice

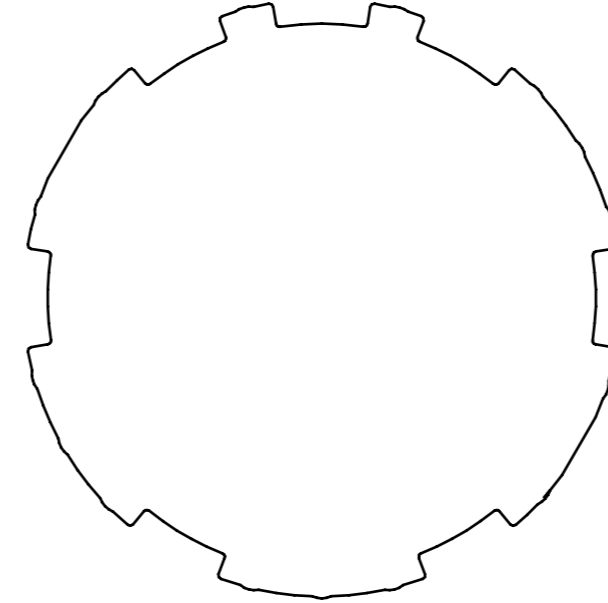

230.930001
Notch 98x2 / 100x3 / 101.6x3.6 / 102x3.5
wheel + crown

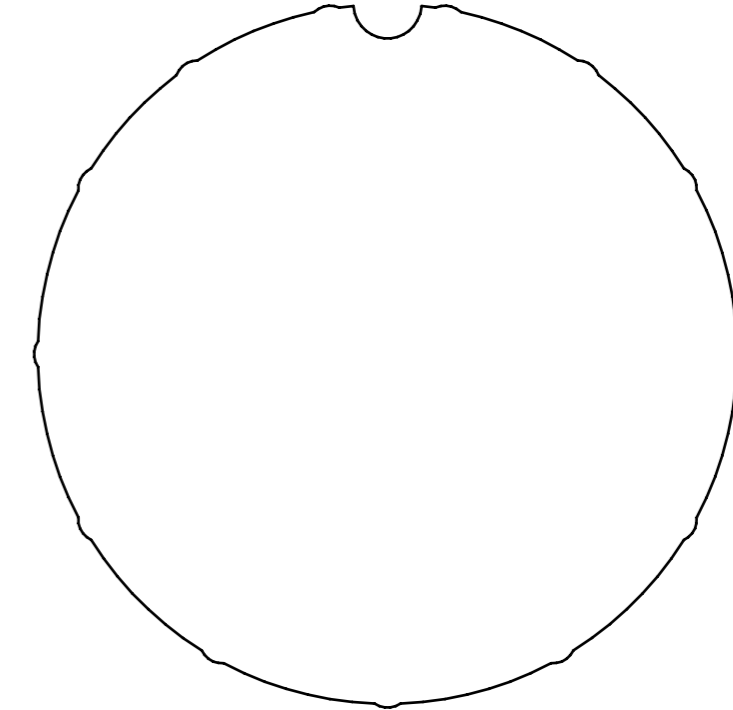

230.520001
Round 98x2 / 100x3 / 101.6x3.6 / 102x3.5
wheel + crown

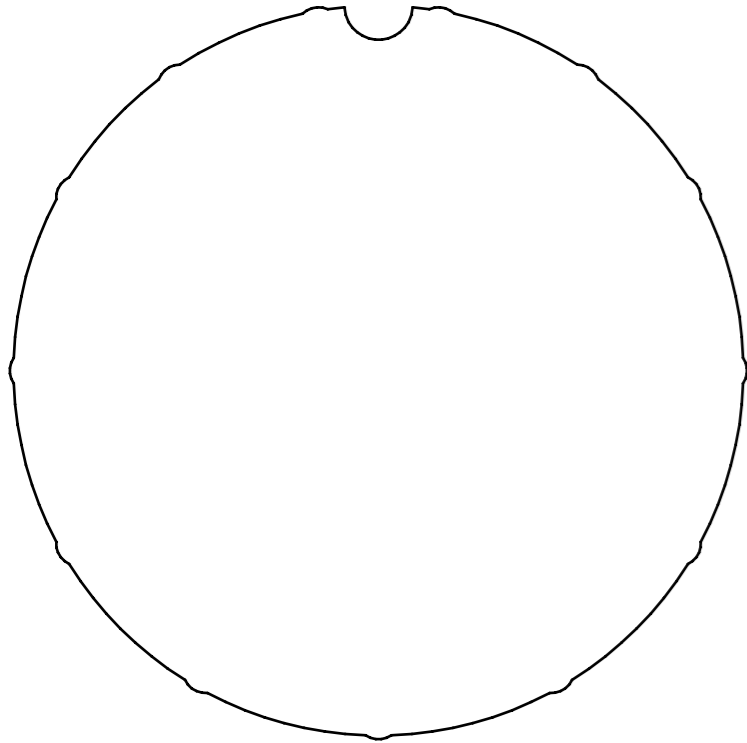

230.510001

Round 102x1.5
wheel + crown

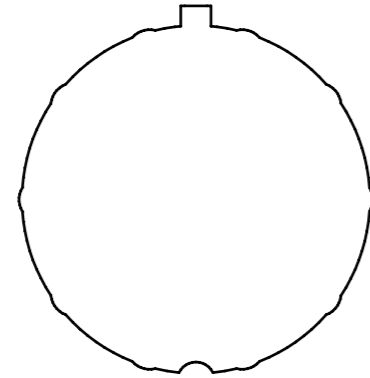

131.219301

Round 50
wheel + crown

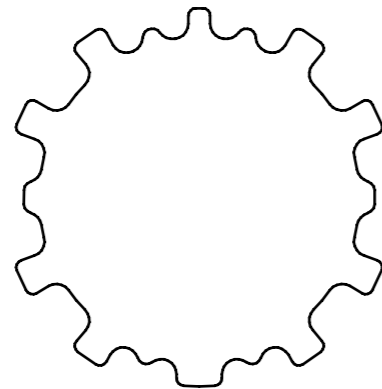

131.161001

Notch 54
wheel + crown

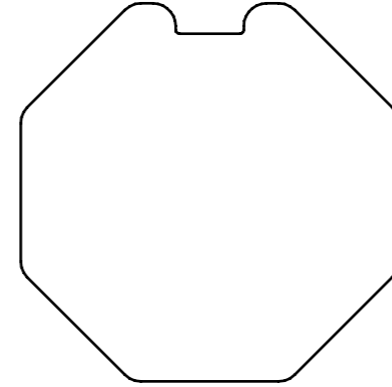

230.120001

Octagonal 50
wheel + crown

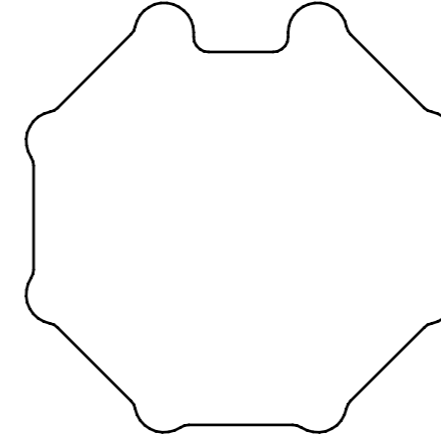

230.360001

Octagonal 60
wheel + crown

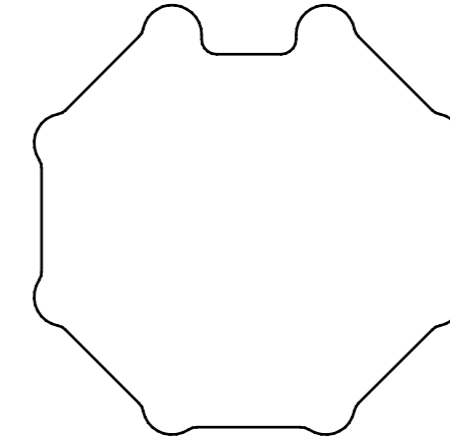

233.790001

Octagonal 60
wheel + ring crown

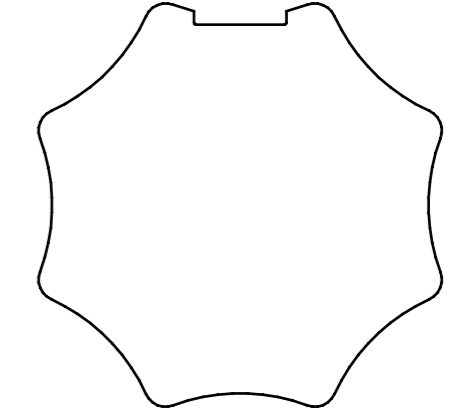

230.560001

Octagonal 60
wheel + crown

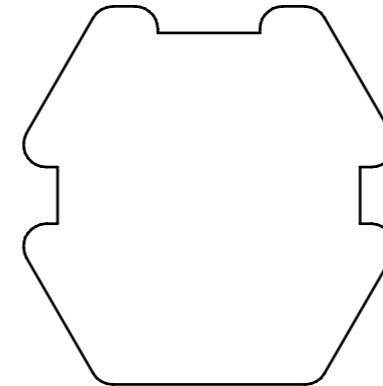

230.470001

Hexagonal 60
wheel + crown

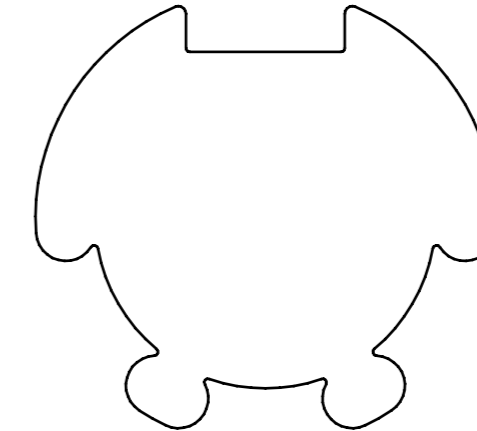

230.430001

Notch 62
wheel + crown

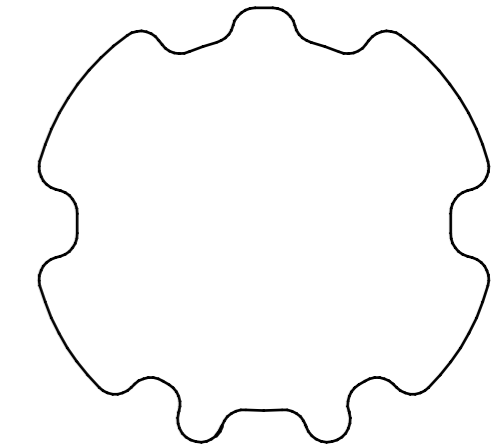

233.800001

Notch 64
wheel + crown

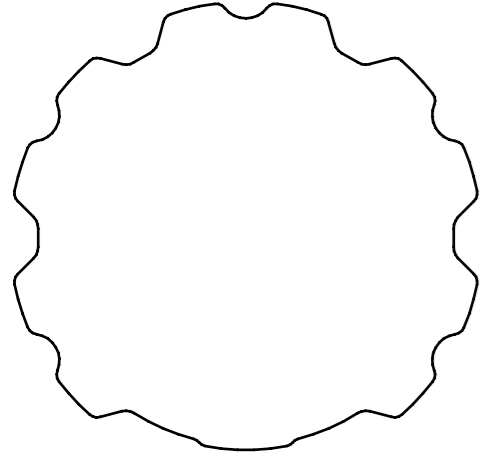

230.320001
Notch 65
wheel + crown

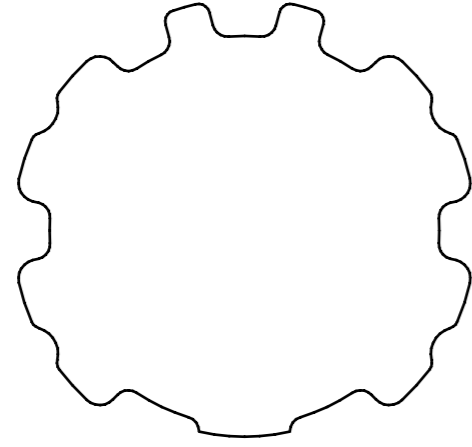

230.330001
Notch 65
wheel + crown

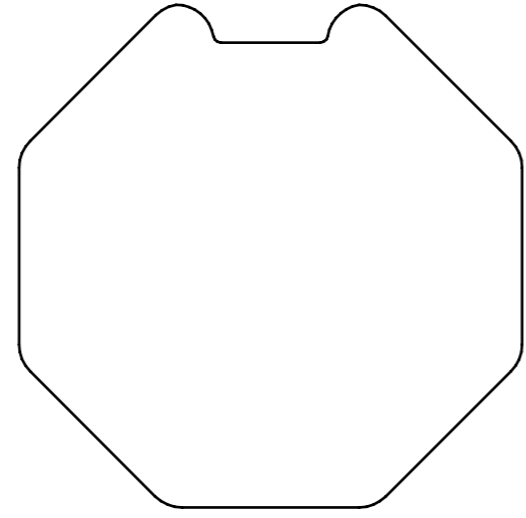

230.110001
Octagonal 70
wheel + crown

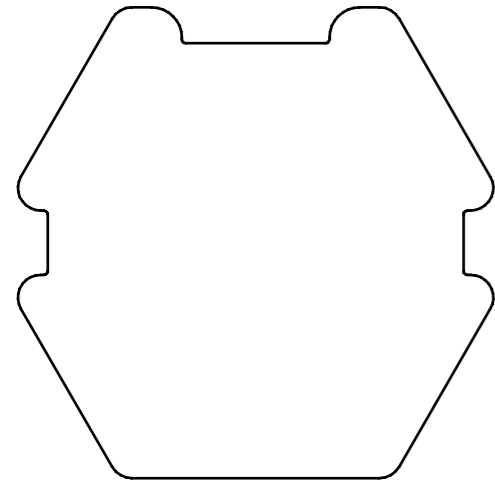

230.590001
Hexagonal 75
wheel + crown

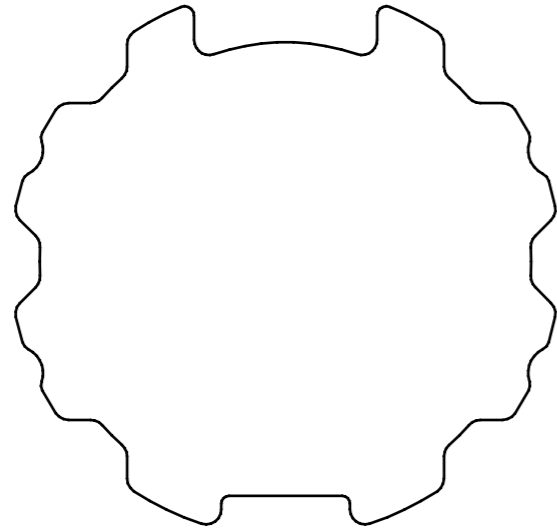

230.340001
Notch 76x1.2
wheel + crown

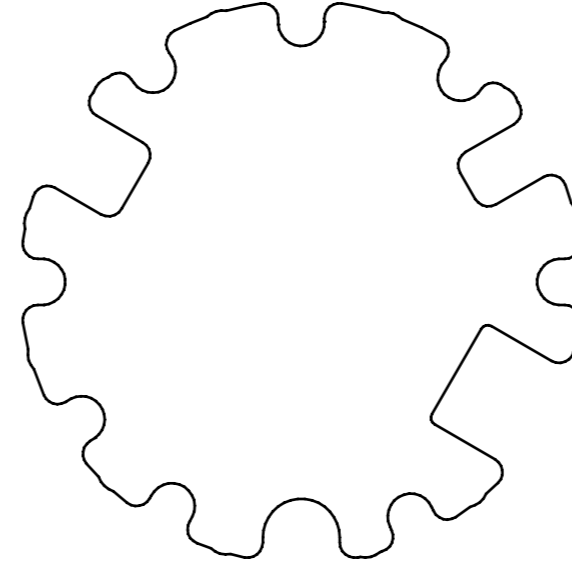

230.400001
Notch 78x1
wheel + crown

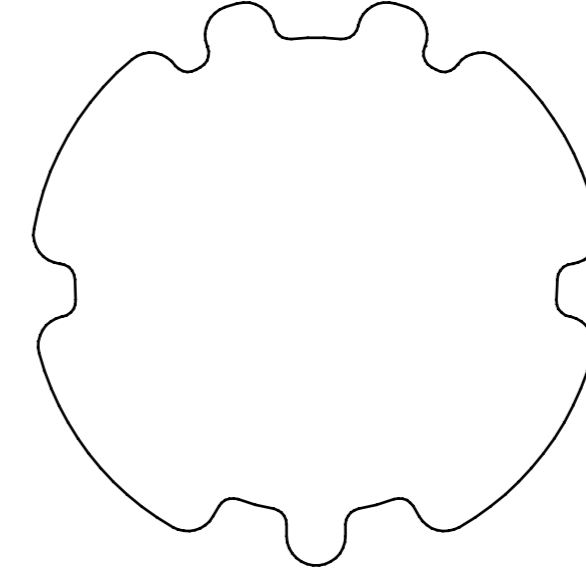

233.820001
Notch 80
wheel + crown

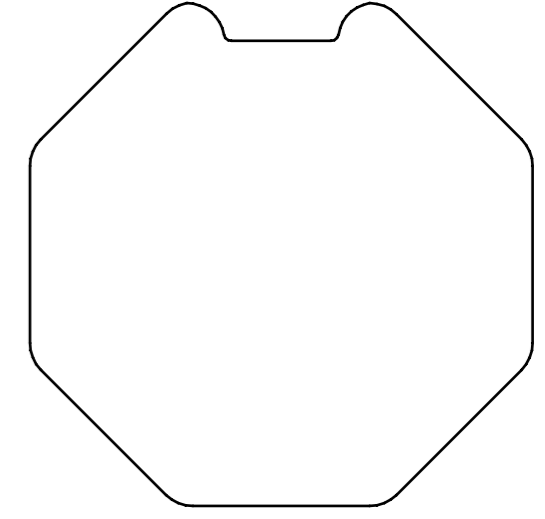

220.200001
Octagonal 70
wheel + crown

For a complete list of compatible adapters, please refer to the **Sun Shading Solutions catalog**.

To access the catalog, you can scan the QR code or directly click on it.



Nice

Supports

M serie Ø 45 mm

For tubular motors without emergency override mechanism.

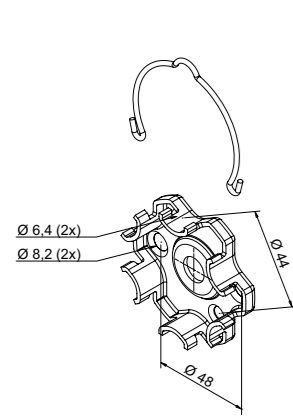

535.10096

Compact aluminium support, with spring.

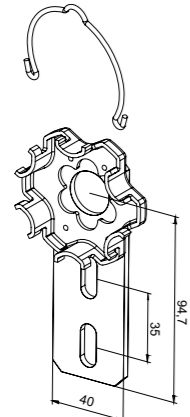

535.10097

Aluminium support, with spring.

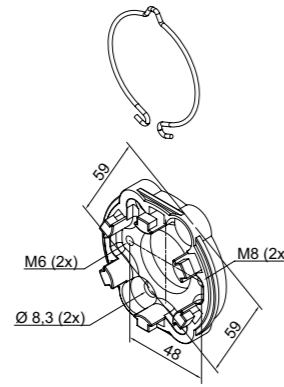

535.10099

Compact aluminium support, with spring.
Holes 48 mm apart (M6) and 4 holes 60 mm apart (M8 and Ø 8.3).

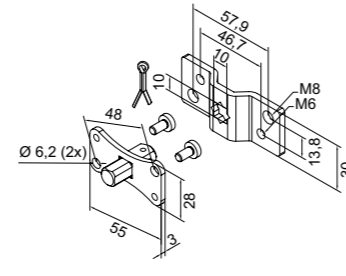

525.10100

10 mm square pin + bracket with star seat 10 mm.

Nice



We make even the smallest of gestures extraordinary.

Nice, a world without barriers.

Automation and control systems for gates, garage doors, blinds, awnings and rolling shutters and alarm systems for all types of space, from private homes to large public buildings.

www.niceforyou.com

Nice SpA
Oderzo, TV, Italy



Nice cares for the environment.
Using natural paper it avoids
excessive use of raw materials
and forest exploitation.
Waste is reduced, energy is saved
and climate quality is improved.